

GEBERIT INSTALLATION SYSTEMS

ALWAYS THE RIGHT SOLUTION



**KNOW
HOW
INSTALLED**



HOW SANITARY FACILITIES COME TO LIFE

No restrictions during room design, quick installation at the building site, very little interfacing with other tradesmen and an optimal price-performance ratio. Customers and clients would expect nothing less when it comes to planning and implementing bathrooms and toilets. With Geberit installation systems, you have the right solution to meet every challenge.

CONTENT

06 **GEBERIT CONCEALED CISTERN TECHNOLOGY**
Technology you can rely on



22 **GEBERIT ONE**
Perfectly coordinated installation solutions

08 **THE RIGHT SYSTEM FOR EVERY SOLUTION**
Geberit Duofix, Geberit GIS and Geberit Kombifix



26 **WIDE RANGE OF APPLICATIONS**
Innovative solutions for better bathrooms

38 **MAINS CONNECTION TO THE WC**
One connection, many options

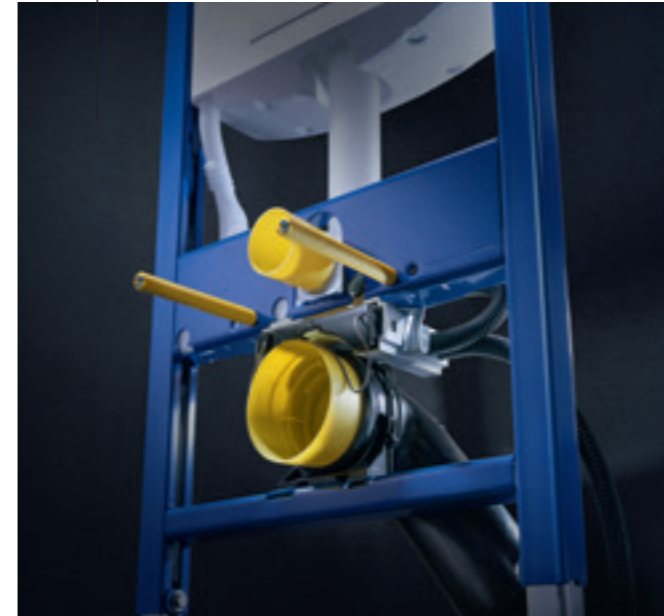

46 **PUBLIC SANITARY INSTALLATIONS**
Always on the safe side

44 **THE GEBERIT DESIGN FAMILY**
To each their own



52 **GEBERIT COMPETENCES**
Sound insulation and planning software

GEBERIT CONCEALED CISTERN TECHNOLOGY

ON WHICH YOU CAN RELY

The launch of the WC cistern for in-wall installation paved the way over 50 years ago. Sanitary technology disappeared from the user's view and the bathroom became a room in which one could relax and feel comfortable.

Throughout the decades, Geberit has continuously created innovations which made behind-the-wall sanitary technology the current preferred solution for plumbing engineers and designers of sanitary facilities.



AN EVENTFUL HISTORY, CONSTANT INNOVATION

1964	1982	1993	1996	2008	2011	2014	2016	2017	2019
Geberit in-wall installation cistern – the birth of concealed cistern technology	Geberit Kombifix – the concealed cistern as a pre-mounted installation element	Geberit GIS – a permanent prewall system in no time	Geberit Duofix – highest possible level of design flexibility for professionals	Geberit Sigma concealed cistern 12 cm – first concealed cistern that can be mounted tool-free	Geberit DuoFresh – the realisation of the integrated odour extraction unit	Geberit shower element with wall drain – the elegant solution for floor-even showers	Geberit urinal system – intelligent planning, installation and maintenance; water-saving operation	Geberit tap system – faultless installation of electronic wall-mounted taps	Geberit ONE offering pioneering, fully integrated and comprehensive solutions for the entire bathroom

FOR ALL CIRCUMSTANCES GEBERIT DUOFIX

- Universal individual elements for drywall construction
- Can be enlarged for complete prewall and partition wall installation
- Maximum design freedom owing to the slim construction
- Optimal sound decoupling

↑
Geberit Duofix element for wall-hung WC, ready for installation and equipped with cistern, conduit pipes and electrical connection point for a Geberit AquaClean shower toilet.



With Geberit Duofix, the plumber and the sanitary engineer can choose from a comprehensive range of universal self-supporting installation elements. Together with the associated rails and studs, these elements can be used to create complete, statically load-bearing prewall and partition wall installations including tile-bearing panelling – and all this quickly and cleanly on site. These enable free placement of the various sanitary appliances. Room-height prewalls do not require anchoring on the back side.



← You can find the control electronics, mixing valve and additional components of the Geberit Duofix element for an electronic wall-mounted tap in a separate function box where they are protected yet still easily accessible.

THE WHOLE RANGE OF GEBERIT DUOFIX

Whether it's a new construction or a renovation: the wide range of Geberit Duofix installation elements provides impressive solutions for both conventional and unusual construction situations. An overview.



↑ **CUSTOM SEAT HEIGHT**
Height-adjustable Geberit Duofix element for wall-hung WC with Sigma concealed cistern, 12 cm, for age-appropriate living.
111.396.00.5



↑ **FLUSH ACTUATION AT THE TOP OR FRONT**
Geberit Duofix element for wall-hung WC with Omega concealed cistern, 12 cm, in three installation heights.
111.030.00.1



↑ **FLOOR-EVEN SHOWER**
Geberit Duofix element for shower with wall drain.
111.591.00.1



↑ **VANDAL-RESISTANT FLUSHCONTROL**
Geberit Duofix element for urinals for hidden and vandal-resistant urinal flush control.
111.689.00.1



↑ **FOR BIDETS**
Geberit Duofix element for bidet.
111.520.00.1

GEBERIT DUOFIX

INSTALLATION TECHNOLOGY TRIED AND TESTED

Geberit Duofix provides you with a variety of design possibilities – whether it's used as a single element or in a system. The advantages of the sophisticated installation technology with infinitely variable positioning options come into full effect for everyday operations on building sites.



↑
Stepped setting of the outlet bend for the Geberit Duofix element for wall-hung WC.



↑
Simple, precise height adjustment using position-holding feet.

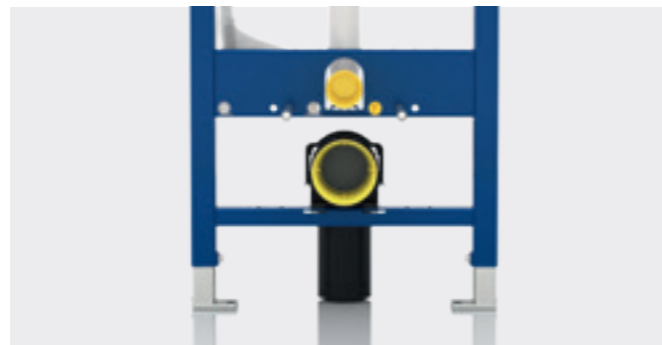

↑
Predetermined positions for water and mains connections.

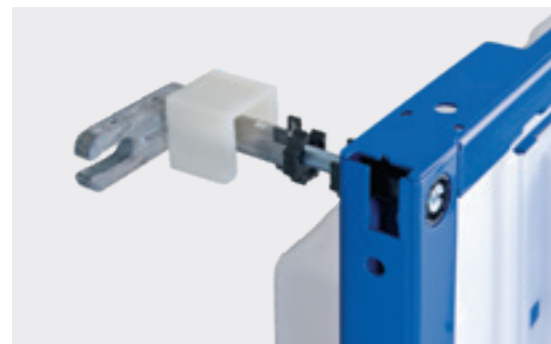

↑
Comfortable depth adjustment from the front thanks to the installation kit for direct anchoring on the building.

All Geberit Duofix installation elements are prepared at the plant so that they can be installed quickly at the building site and connected with the required water supply and drainage. The work can easily be carried out by a single person. Self-cutting screws are used to fasten the element to a frame structure on a lightweight wall. Geberit provides an installation kit for direct anchoring on the building structure which you can use to comfortably set the depth adjustment from the front.

You can have a complete partition wall installation with tile-bearing panelling in an instant with the Geberit Duofix system rails for ceiling and floor as well as the room-height studs. You can easily fix the studs into the ceiling rail and pull them out from the bottom with a simple 90° turn. Thanks to the telescopic technology, you can do this without tools and without cutting to length. The studs are secured with a spring clip in the system rail on the floor. A swivelling head also facilitates installation with roof pitches.



↑
Attach the Geberit Duofix acoustic insulation tape and anchor the system rails in the floor and ceiling.



↑
Screw the Geberit Duofix studs into the ceiling rail and pull out the telescopic extension downward.



↑
Place the Geberit Duofix installation element in the correct position. For part-height prewalls, fasten with a wall anchor...



↑
... and then secure using Geberit Duofix system rail clips.

GEBERIT GIS QUICK AND FLEXIBLE

↑
With Geberit GIS, support systems, installation elements and panelling become complete, tile-bearing sanitary walls in just a few steps.

- Flexible system, sophisticated connection technology
- Quick installation of the installation elements
- Easy compensation of dimensional tolerances
- Reliable sound decoupling
- High level of material and work calculation reliability

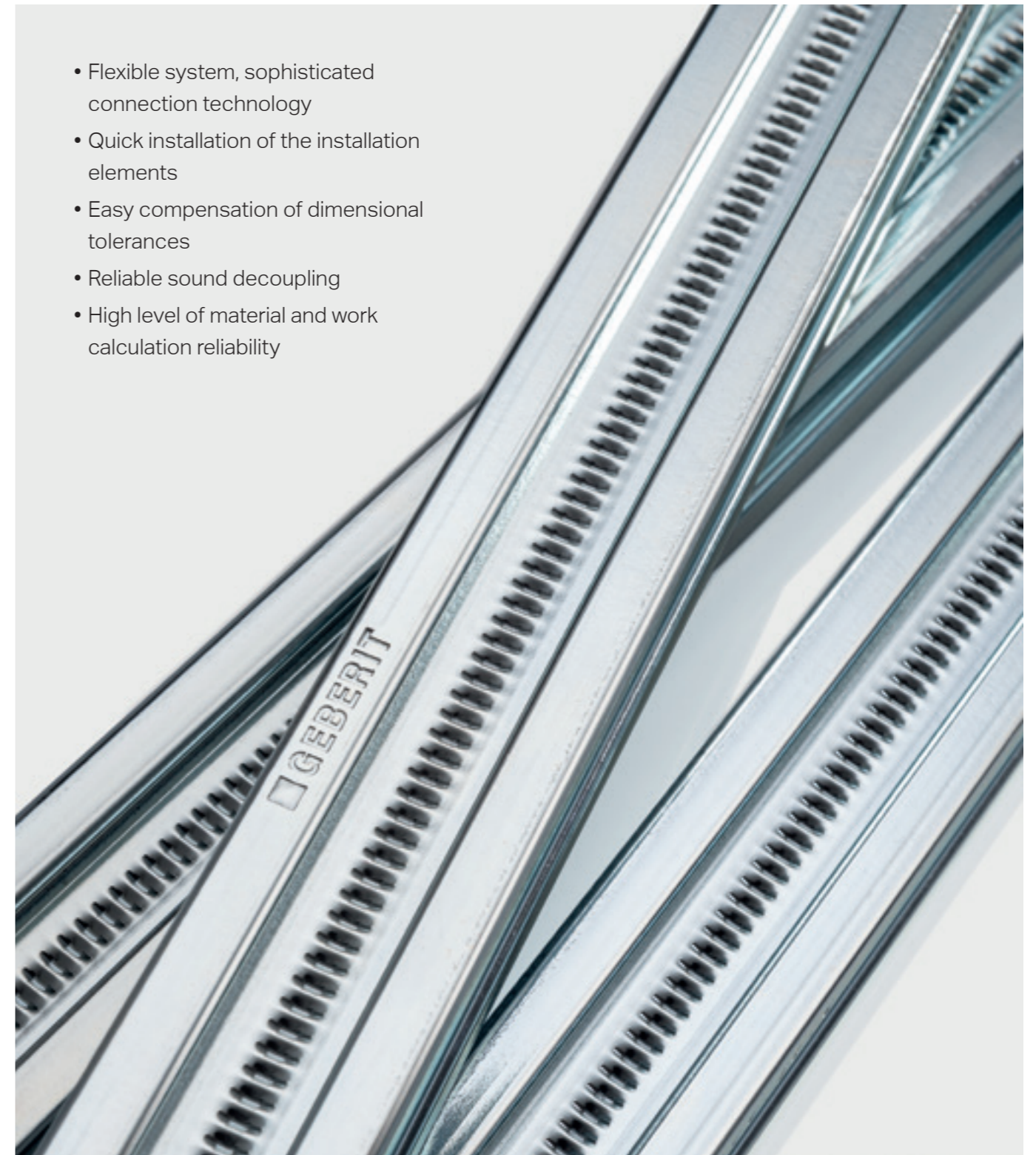

Geberit GIS provides the suitable connection for virtually any sanitary appliance and perfectly meets the challenges of barrier-free use. A single person can carry out the assembly and the final installation thanks to the sophisticated connection technology which has been tested in practical trials.

The advantages of Geberit GIS can be seen right from the start: the planning software Geberit Pro-Planner supports plumbing companies while they create the floor plan and front view as well as the material and parts lists – the best possible basis for reliable calculation.

EVERYTHING UNDER CONTROL WITH GEBERIT GIS



↑
MOUNTING PLATE
For the concealed or exposed installation of taps and connections as well as support handles.
461.035.00.1



↑
VANDAL-RESISTANT FLUSH CONTROL
Geberit GIS element for urinals for hidden and vandal-resistant urinal flush control.
461.696.00.1



↑
FLOOR-EVEN SHOWER
Geberit GIS element for shower with wall drain for all conventional wall and floor constructions.
461.736.00.1



↑
FOR FREESTANDING SYSTEM WALL
Geberit GIS leg support for freestanding system wall.
461.190.00.1



↑
FOR ROOF PITCH
Geberit GIS adjustable roof pitch angle.
461.191.00.1



↑
FOR WASHBASINS
Geberit GIS element for wall-mounted tap and function box.
461.146.00.1



→ Geberit GIS profiles can be permanently joined with the Geberit GIS profile connectors extremely quickly and without tools.

GEBERIT GIS

A DIRECT PATH TO THE SANITARY WALL

Insert, align, press shut: Geberit GIS profiles can be permanently joined with the special profile connectors extremely quickly, thus creating a complete support system quickly and without tools out of just two components.

With a dovetail groove, the Geberit GIS profiles are optimally prepared for the installation of the elements. Geberit GIS profile connectors or Geberit GIS ratchet pins are used to securely fasten them to the prepared support system.

The Geberit GIS mounting brackets ensure that the sanitary wall is securely anchored to the building structure. Sound insulation bases made of cork ensure that the support system is effectively sound decoupled from the building.



↑
Up to four Geberit GIS profiles can be cut to length at the same time with the chop saw.



↑
Assembly of the Geberit GIS profiles: everything is fixed with a single click.



↑
The Geberit GIS mounting brackets with sound insulation bases made of cork ensure that the support system is securely anchored and reliably sound decoupled.



↑
The Geberit GIS installation elements can be fixed quickly and reliably.



↑
The Geberit GIS installation system is perfectly suitable for prefabrication at the workshop. Work on the building site can therefore be carried out much more efficiently.

GEBERIT KOMBIFIX

THE COMPLETE RANGE FOR BATH AND WC

The Geberit Kombifix installation element range covers virtually every sanitary facility for bath and WC. Designed for use in solid construction, the ready-to-fit installation elements can be installed and connected to all connections quickly and securely.



↑
WC ELEMENT, STANDARD VERSION
Geberit Kombifix element for wall-hung WC with Sigma concealed cistern 12 cm.
110.300.00.5



↑
SLIM WC ELEMENT
Geberit Kombifix element for wall-hung WC with extra-slim Sigma concealed cistern 8 cm.
110.790.00.1



↑
FOR URINALS
Geberit Kombifix element for urinals, for hidden urinal control.
457.689.00.1



↑
FOR SHOWER DRAIN BEHIND THE WALL
Geberit Kombifix element for shower with wall drain.
457.534.00.1



↑
FOR WASHBASINS
Geberit Kombifix element for washbasin with deck-mounted taps.
457.430.00.1



↑
FOR BIDETS
Geberit Kombifix element for wall-hung bidets.
457.893.00.1



←
The tried-and-tested Geberit Kombifix installation elements are the perfect solution for masonry and concrete walls.

- Installation elements for use in solid construction
- Delivered ready to install
- Well-established across the world for over 30 years

GEBERIT ONE

WHEN FUNCTION AND DESIGN BECOME ONE



Geberit ONE offers pioneering and comprehensive solutions for the whole bathroom. Cleverly combined into a single system, Geberit ONE boasts a whole host of obvious and more subtle advantages. This is how to successfully create better bathrooms for your customers.

EASY TO PLAN AND INSTALL

Geberit ONE considerably simplifies the planning and installation of a wide range of components where there were previously hardly any viable solutions. For example, planning and mounting a wall-mounted tap with millimetre precision or integrating a shower niche with factory-set sealing foil. Geberit ONE's scope of services also includes simplified planning and installation of a mirror cabinet recessed behind the wall.

FUNCTIONAL DESIGN IN FRONT OF THE WALL

A new outlook on life with this puristic style. Geberit ONE proves itself all along the line with its elegant design and makes cleaning easier throughout the bathroom with its outstanding function.



↑
The classic 48 cm projection washplace model can now be combined with standard installation elements.

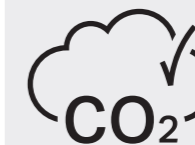

Geberit is now supporting a forest protection project of the Swiss myclimate foundation in Tanzania. With this voluntary contribution, the company offsets the unavoidable CO emissions that arise during ceramic production. All ceramic products in the Geberit ONE series have been included in this initiative from the beginning of 2023.

→ <https://www.geberit.co.za/know-how/sustainability/>

GEBERIT ONE

PROVEN KNOW-HOW BEHIND THE WALL

Geberit installation systems have established themselves among professionals over the years and are valued for their seamless functionality, simplicity and highest quality. The use of the prewall is continued with Geberit ONE with additional elements and continuous connection to the system. However, there is no need to spend extra time learning new things.



↑
New Duofix installation element for a continuous installation solution behind the wall and flexibility for the washplace design in front of the wall:

- The concealed installation mirror cabinet box facilitates installation of the mirror cabinet.
- The flexible wooden panels allow washbasins and washbasin cabinet bathroom furniture of different widths to be installed safely.
- The new element for washbasin for the Geberit ONE wall-mounted tap means the washbasin can be chosen freely.



↑
The Geberit ONE WC fits the tried-and-tested Geberit installation elements for the WC, but can also be combined with installation technology from other suppliers.



↑
The narrow Duofix washbasin installation element facilitates easy installation of both narrow washplaces (60 cm) and double washbasins (120 cm) – two installation elements are required for this.



↑
With the installation set, the niche storage box becomes a fixed component of the shower area, the place for which can be reliably planned and determined during the installation phase.



↑
The Geberit niche storage box is equipped with a pre-mounted sealing foil for working into the composite seal, making it an integral component of the installation system.



↑
The angle gear with optimised force transmission facilitates simple and fast mounting of the Geberit ONE WC ceramic appliance.



↑
The Geberit ONE WC can be adjusted in height not only during installation, but also years later, without having to intervene in the prewall.

WIDE RANGE OF APPLICATIONS INNOVATIONS **FOR** **BETTER BATHROOMS**

Innovative sanitary technology which performs reliably either behind or in front of the wall, and provides versatile possibilities for clever room design and optimal use of space. Geberit installation systems and Geberit Monolith sanitary modules perfectly fulfil the prerequisites to allow a professional to meet all the presented challenges.

COMPLETE FLEXIBILITY

The world's sanitary facilities are luckily very diverse. Every construction task has its own distinctions, every customer has their own requirements and every time period has its own trends and vogues. Geberit meets this diversity with complete flexibility in its installation systems. This flexibility comes into effect when the barrier-free use is suddenly required or when spatial circumstances require improvisation. In the following pages, you will see just how diverse the system solutions are.

VISUAL APPEAL IS NOT ENOUGH

Real beauty is not only visible, but also palpable, if not always straight away. When it comes to Geberit products, there is always functional added value behind every flawless design. This added value becomes apparent during the installation, when service and maintenance is needed, and of course, during use. Urinals, taps and the floor-even shower: evidence of the indispensable added benefits can be found everywhere – this proof is summarised on the following pages.



↑
The Geberit installation systems form the basis which allows the effect of the creative elements to unfold in the bathroom.

→
What can you expect from Geberit?
An elegant design which conceals the functional added value.



WIDE RANGE OF APPLICATIONS

A CLEAN AFFAIR

FLOOR-EVEN SHOWER

GEBERIT WALL DRAIN FOR SHOWERS

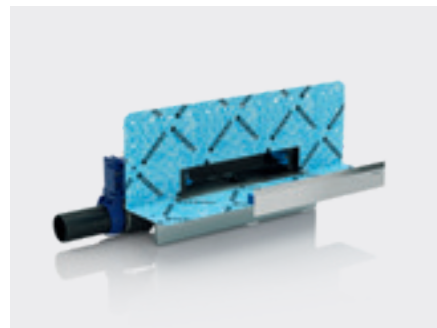

↑ The Geberit GIS and Geberit Duofix installation elements significantly reduce the amount of work required and also guarantee a tight, longlasting connection.



↑ Thanks to the low water seal depth, the Geberit wall drain for showers is also particularly suitable for situations with a low screed height.



↑ A slight slope can be created in the floor by installing an additional collector profile. This significantly simplifies interfacing with the tiler.



↑ The integrated comb insert can be easily removed for cleaning.

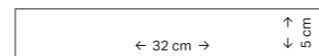

COLOURS/PRODUCT MATERIALS



Bright chrome-plated



White alpine



Stainless steel brushed



Stainless steel polished



black matt



Tiled according to preference



You can exploit the full potential of floor-even bathrooms by laying the water outlet behind the wall. This type of installation has proven its worth for bathroom renovations as well as for new buildings – long before the visual benefits come to light.
→

- Closed, visually attractive floor surface
- Easy connection to the available discharge pipes
- Simplified interfacing with the tiler
- Practical cleaning

GEBERIT MONOLITH PLUS SANITARY MODULE

BEAUTIFUL ON THE OUTSIDE, CLEVER ON THE INSIDE

The Geberit Monolith sanitary module for WC is compatible with most standard WC ceramic appliances as well as with the Geberit AquaClean shower toilets. It is equally suitable for new building projects and renovations.
→



Thanks to its timeless design and versatile positioning options, the Geberit Monolith sanitary module for WC is a first-rate alternative to an exposed cistern. With its water-saving dual flush and first-class materials, even the basic model meets high demands. A new lighting concept with four dimmable lighting moods and the proven odour extraction system are integrated into the updated Geberit Monolith Plus sanitary module. All electronic functionalities can be controlled via the Geberit Home app. This also includes an interval flush, which ensures that the water pipes and the cistern are flushed regularly during longer absences. The fact that the supporting frame design is similar to the tested Geberit Duofix installation element is particularly useful for the plumber – the Geberit Monolith can therefore be anchored to the building by following a familiar procedure.



- Front cladding made of heavy-duty toughened safety glass and stoneware (concrete look and slate look)
- Brushed aluminium side cladding in natural or black chrome
- Very slim with a depth of only 10 cm
- Suitable for new construction and renovation
- The installation is carried out according to the Geberit Duofix installation system mounting model
- The new soft-touch buttons, integrated into the top cover for two flush quantities (Monolith Plus only), trigger the flush electronically.



WIDE RANGE OF APPLICATIONS

ACHIEVE YOUR GOAL QUICKER THANKS TO THE WELL-KNOWN

The support frame design of the Geberit Monolith sanitary module for WC is similar to the tried-and-tested Geberit Duofix installation element, which is well-known to almost all sanitary professionals. The sanitary module offers almost unlimited installation options, which is a great advantage for renovations in particular. Surrounding conditions such as skirting boards or an awkwardly positioned water supply connection no longer lead to costly adjustments, meaning there is no need to fear.



SIDE CLADDING



Aluminium brushed

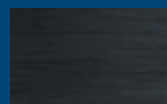

Black chrome Aluminium brushed

FRONT CLADDING

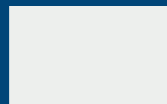

White (SI)

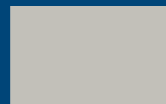

Sand grey (JL)



Concrete (JV)



Black (SJ)

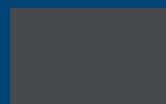

Lava (JK)



Slate (00)

← The front cladding made of safety glass is available in the colours white, sand grey, black and lava. There is also the option to have the front cladding in a stoneware concrete look or stoneware slate look.

The aluminium brushed side cladding can be combined with white, sand grey, and stoneware concrete look surfaces, while the black chrome side cladding works well with the lava, black and stoneware slate look.

The Geberit Monolith sanitary modules offer almost unlimited installation options, which is a great advantage for renovations in particular. Thanks to the new frames and optional mounting aids, almost anything is possible.

REMARKABLY EASY

The frame of the Geberit Monolith sanitary module for WC can therefore be anchored to the building by following a familiar procedure.



↑ The height setting can be adjusted to the surroundings within a range of 7 cm. This does not require any special tools.



↑ The frame has two adjusting screws to compensate for any wall slants.



↑ Tried-and-tested mounting brackets are used to fasten the frame to the building structure.



↑ The reinforced braided hose for the water supply connection can be built in without having to remove the flush water tank – that's one less step.

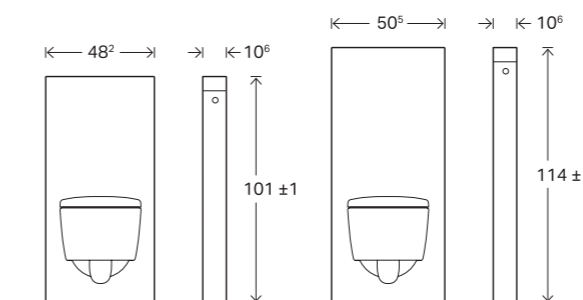

← Geberit Monolith and Geberit Monolith Plus are available in heights of 101 cm and 114 cm.

WIDE RANGE OF APPLICATIONS

FLEXIBILITY INCLUDED

BARRIER-FREE & SPACE SAVING

Regardless of whether you are facing a tricky construction situation or if age is taking its toll, there's no reason to forego your usual comfort. With the Geberit GIS and Geberit Duofix installation systems, you can set up bathrooms which will delight users in the long term even on small surfaces.

Geberit has developed special WC installation elements for installation under window parapets or a height-adjustable WC. The latter of which allows a subsequent adjustment of the seat height to up to 49 cm. Furthermore, support handles can also be subsequently professionally installed on both sides of the WC using mounting plates.



↑
Geberit Duofix element for height-adjustable wall-hung WC.



↑
Geberit Duofix element for wall-hung WC, 82 cm, with Omega concealed cistern.



↑
You can install a space-saving Geberit Omega concealed cistern in front of a window parapet. It is available in three installation heights and can be connected to the water supply at the back or at the side. You can choose to have the small, elegant actuator plates at the front for the flush actuation.

GEBERIT CONCEALED CISTERN WITH HS30/HS50 HYGIENE FLUSH UNIT

PROGRESS NOT STAGNATION

The integrated Geberit HS30 / HS50 hygienic flush units with usage detection generate a regular water replacement. The hygiene flush unit is only actuated when the toilet is not in use. This avoids unnecessary water consumption. The integrated hygiene flush unit is suitable for closed sections with small flush volumes.

COMPACT SOLUTION

The product is integrated into the concealed cistern. The water is drained via the WC ceramic appliance, meaning that no additional drainage connection is required. Thanks to its compact design which does not take up any extra space, the integrated hygiene flush unit is suitable for all applications where the installation of a WC is already planned, where space is tight or where a visible service plate is not wanted.

MODELS

The integrated hygiene flush unit is available for the Geberit GIS and Duofix installation systems and with one or two water supply connections. The HS30 hygiene flush unit can be used with interval or timed flush. If a temperature sensor is installed, the HS50

can also flush regularly depending on the temperature in the pipes. The Geberit Control app can be used to configure flushing programmes and read out flush protocols. All hygiene flush unit units feature a malfunction contact, backpressure sensor, automatic data storage function and a function test for every component.

ACTUATOR PLATES

The cistern can be combined with all mechanical actuator plates in the Geberit Sigma01, 10, 20, 21, 30 and 50 series, as well as with all WC ceramic appliances.

ECONOMICAL

The Geberit HS05 hygiene flush unit is a cost-effective and easy-to-install solution for drinking water hygiene in a cold-water system. It can be used in all Geberit Sigma concealed cisterns with a depth of 12 cm and can be retrofitted at any time.

MAXIMUM FREEDOM OF DESIGN

The Geberit 05 hygiene flush unit is compatible with all mechanical Geberit actuator plates ranging from Sigma01 to Sigma60. Depending on the local conditions, power can be supplied by a mains connection or batteries.

←
Geberit HS05Hygiene flush unit
for Geberit Sigma concealed
cisterns.



NEW

OPERATION, MAINTENANCE AND RECORDING VIA THE GEBERIT CONTROL APP

The free Geberit Control app is available for download from the App Store for iOS or from the Play Store for Android.



Geberit Control app



CONNECTION FOR THE TOILET

ONE CONNECTION, MANY OPTIONS

A mains connection for the toilet provides various options for more convenience in the bathroom. If it is already included during the construction phase, electrically operated functions can be installed without problems at a later stage. The Power & Connect Box from Geberit makes life significantly easier for sanitary specialists.

A PREREQUISITE FOR ULTIMATE TOILET CONVENIENCE

An electrical connection for the toilet is a prerequisite for a variety of functions that make for a very convenient bathroom experience. A power supply is needed for odour extraction, orientation light in the night, touchless flush actuation or Geberit AquaClean shower toilets for hygienic cleaning with fresh water. Future developments could also integrate the toilet into smart home systems, so preparing power and communication connections for every toilet when fitting or renovating the bathroom is a must. Doing so ensures that it is possible to add electrical functions to the WC area at any time.

THE POWER & CONNECT BOX IN THE CONCEALED CISTERN

Geberit has developed the Power & Connect Box for the toilet to make it easy to install electrically operated function elements. It can be integrated into the Geberit Duofix and GIS installation elements for Sigma and Omega concealed cisterns with 12 cm installation depth and is included at the factory in some versions. The box is installed behind the ceramic appliance, invisible from the outside, and can be combined with all toilets.

- 1 Actuator plate with invisible integrated odour extraction and orientation light.
- 2 Geberit AquaClean shower toilet for gentle cleaning with water.
- 3 Touchless flush actuation with orientation light.



Modern comfort functions improve both the bathroom and quality of life. A mains connection for the toilet enables installation or retrofitting.



ORIENTATION LIGHT

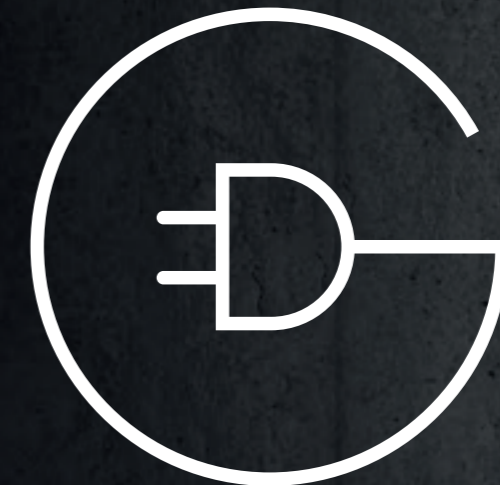

SHOWER TOILET



ODOUR EXTRACTION UNIT



INTEGRATED HYGIENE FLUSH



TOUCHLESS FLUSH ACTUATION

A MAINS CONNECTION TO EVERY TOILET – IT'S THAT SIMPLE



- Installation set: Easy prefitting for retrofitting mains connections
- Ready-to-fit set: Connection plate with power supply unit
- Clean separation of trades between sanitary specialists and electrically skilled persons

CLEAN INTEGRATION INTO THE ELEMENT FOR WALL-HUNG WC



↑ The installation set and ready-to-fit set are concealed behind the ceramic appliance.



↑ A protection box ensures that the box remains clean during construction work.

The Power & Connect Box is available as an installation set and a ready-to-fit set. In all cases, the installation set should be mounted together with the installation element and fitted with the conduit pipe by an electrically qualified person. This ensures that the mains connection can be retrofitted with minimum effort.

INSTALL THE READY-TO-FIT SET, MAKE THE CONNECTIONS

The ready-to-fit set is used when electricity is actually needed at the WC. It consists of a connection plate, 12 volt power supply unit and a special cable. The connection plate is connected to the power supply by an electrically qualified person. All other connections are made by sanitary specialists. In this way, the Power & Connect Box creates a clean interface between trades for electrically qualified persons and sanitary specialists.



1



2



3



4

- 1 Insert the connection plate into the installation set.
- 2 Plug in the power supply unit.
- 3 Easy connection: The plug for connecting a Geberit AquaClean shower toilet.
- 4 The LED light indicates whether the power supply is working properly.

GEBERIT DUOFRESH MODULE FRESH AIR FOR EVERYONE



↑
As long as there is a mains connection, the Geberit DuoFresh module can be retrofitted in most Geberit concealed cisterns that were installed within the last 10 years.

The Geberit DuoFresh module extracts unpleasant odours directly from the WC ceramic appliance. The extraction unit that accompanies it, the ceramic honeycomb filter, an insert for Geberit DuoFresh sticks and an orientation light can be found in an easily accessible location behind the actuator plate.

HYGIENE OPTIONS THAT CAN ALSO BE RETROFITTED

The Geberit DuoFresh module can be integrated or retrofitted behind almost every Geberit actuator plate from the Sigma range. A sophisticated swivelling mechanism enables the plate to be moved conveniently to one side, allowing the plumber and the end user to access the hygiene options with ease. Additives that colour the flush water blue and give off a pleasant scent are popular with many end users. Geberit has therefore

integrated an insert for in-cistern sticks alongside the odour extraction and orientation light comfort functions. The insert is located directly behind the actuator plate, making it extremely easy to replenish the cistern with new Geberit DuoFresh sticks. The installation kit includes the swivelling mechanism needed to move the actuator plate.

ODOUR EXTRACTION UNIT WITH ORIENTATION LIGHT

The Geberit DuoFresh module removes

unpleasant odours directly from the WC ceramic appliance – extracting the air through the flush pipe and flush valve, purifying it using a ceramic honeycomb filter and then introducing the cleaned air back into the room. The module also features an LED orientation light which produces a soft glow during night-time visits to the toilet. The air extraction and light are controlled by a proximity sensor system. The installation kit for the odour extraction unit includes an insert for Geberit DuoFresh sticks and a swivelling mechanism for moving the actuator plate. The transformer for the power supply must be ordered separately.

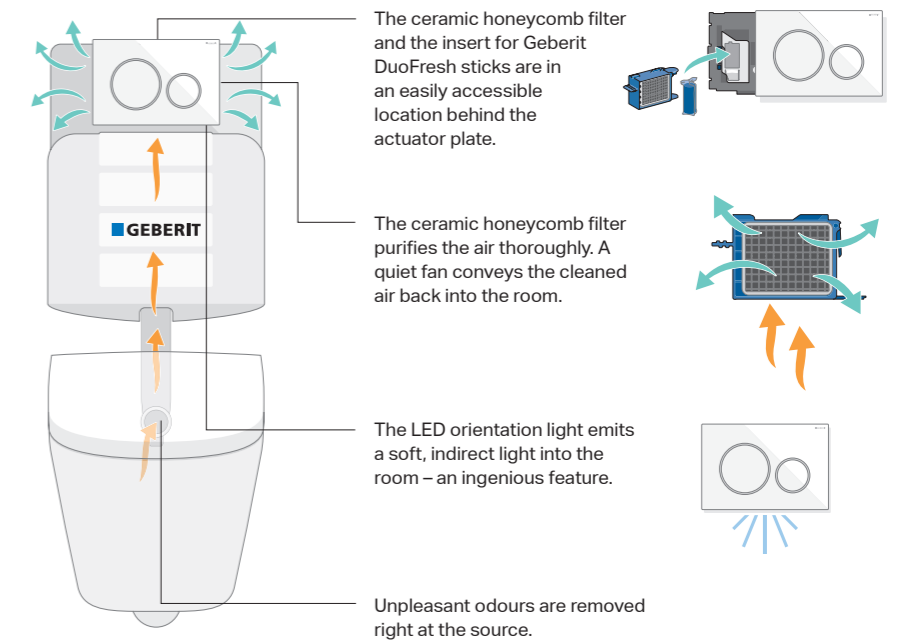

INSERT FOR GEBERIT DUOFRESH STICKS HYGIENIC FRESHNESS FOR WEEKS

Geberit offers the insert for Geberit DuoFresh sticks separately – without the odour extraction unit and light – so Geberit DuoFresh sticks can be used even without the electrically operated comfort functions. Available separately, the insert is suitable for most Geberit actuator plates in the Sigma range, does not need a mains connection and can even be retrofitted. It guides the Geberit DuoFresh stick to a fixed position below the surface of the water in the cistern, where the stick dissolves slowly and ensures a pleasant scent emanates from the entire WC ceramic appliance with every flush.



- 1 It doesn't get any simpler than this: Move the actuator plate to one side.
- 2 Place the Geberit DuoFresh stick in the insert behind the plate.
- 3 Close the plate and enjoy the freshness with every flush.
- 4 Geberit DuoFresh sticks turn the flush water slightly blue and give off a pleasantly fresh scent.

GEBERIT DESIGN FAMILY

TO EACH THEIR OWN ACTUATOR PLATES WITHSTYLE

The actuator plate is one of the most important elements of bathroom design, along with the taps, WC ceramic appliances, as well as wall and floor surfaces. Geberit provides you with the sought-after diversity through its large selection of shapes, colours and models.

The Geberit actuator plates of the Omega series are setting a new standard. With external dimensions of only 184 mm x 114 mm, the surface-even Geberit actuator plate Omega60 requires very little space and provides the plumber with easy access to the service opening of the Geberit Omega concealed cistern. The plates can be attached at the service openings on the front or at the top.

With the Geberit actuator plates of the Sigma series, Geberit offers an exceptionally wide range of design possibilities and functions. Whether you're after dual or stop-and-go flush, manual or touchless operation, an integrated odour extraction unit or surfaceeven installation – you can find a stunning solution for every requirement in the Geberit actuator plate Sigma series.

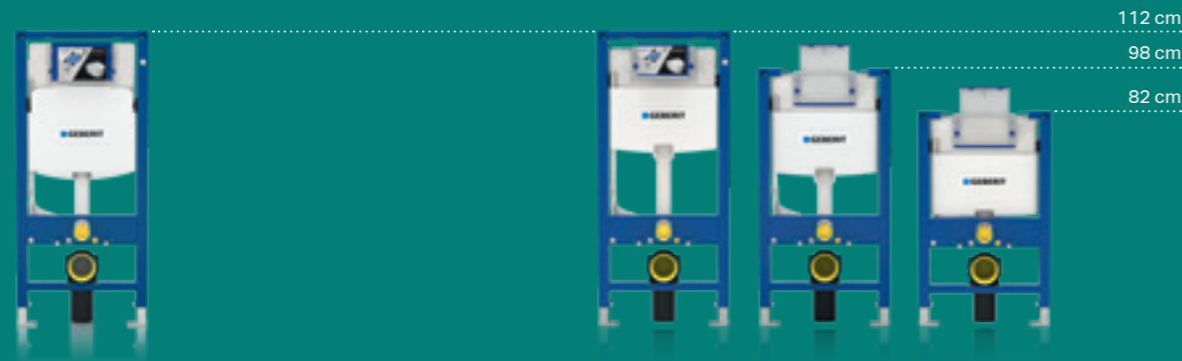









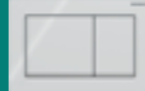
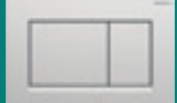





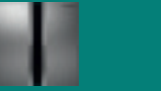







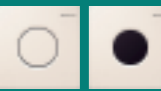

GEBERIT FLUSHING SYSTEM SIGMA

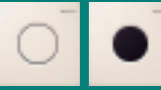
- Geberit Sigma concealed cistern, minimum construction height 110 cm
- (Pre)wall thickness at least 12 cm (shell of a building, without taking the drainage pipes into consideration)
- Front actuation
- Guaranteed availability of functional spare parts for 50 years

GEBERIT FLUSHING SYSTEM OMEGA

- Geberit Omega concealed cistern, minimum construction height is only 82 cm
- (Pre)wall thickness at least 12 cm (shell of a building, without taking the drainage pipes into consideration) for front actuation
- Front or top actuation
- Guaranteed availability of functional spare parts for 50 years

		GEBERIT OMEGA Geberit actuator plates for toilet flush actuation	GEBERIT SIGMA Geberit actuator plates for toilet flush actuation	Geberit cover plates for urinal flush actuation
	30	 <ul style="list-style-type: none"> • Dimensions: 212 x 142 mm 	 <ul style="list-style-type: none"> *** • Dimensions: 264 x 164 mm 	 <ul style="list-style-type: none"> • Pneumatic • Electronic • Dimensions: 130 x 130 mm
	50		 <ul style="list-style-type: none"> *** • Dimensions: 246 x 164 mm 	 <ul style="list-style-type: none"> • Pneumatic • Electronic • Dimensions: 130 x 130 mm
	60	 <ul style="list-style-type: none"> • Surface-even installation • Dimensions: 184 x 114 mm 	 <ul style="list-style-type: none"> • Surface-even installation • Dimensions: 221 x 139 mm 	 <ul style="list-style-type: none"> • Electronic • Dimensions: 130 x 130 mm
	70		 <ul style="list-style-type: none"> • Servo support • Dimensions: 240 x 158 mm 	 <ul style="list-style-type: none"> • Electronic • Dimensions: 130 x 130 mm
	01		 <ul style="list-style-type: none"> *** • Dimensions: 246 x 164 mm 	 <ul style="list-style-type: none"> • Pneumatic • Electronic • Dimensions: 130 x 130 mm
	10		 <ul style="list-style-type: none"> *** • Dimensions: 246 x 164 mm** 	 <ul style="list-style-type: none"> • Pneumatic • Electronic • Dimensions: 130 x 130 mm
	20	 <ul style="list-style-type: none"> • Dimensions: 212 x 142 mm 	 <ul style="list-style-type: none"> *** • Dimensions: 246 x 164 mm 	 <ul style="list-style-type: none"> • Pneumatic • Electronic • Dimensions: 130 x 130 mm
	21		 <ul style="list-style-type: none"> *** • Dimensions: 264 x 164 mm 	 <ul style="list-style-type: none"> • Pneumatic • Electronic • Dimensions: 130 x 130 mm
	10		 <ul style="list-style-type: none"> • Touchless operation • Dimensions: 246 x 164 mm 	 <ul style="list-style-type: none"> • Electronic • Dimensions: 130 x 130 mm
	80		 <ul style="list-style-type: none"> • Touchless operation • Dimensions: 247 x 164 mm 	 <ul style="list-style-type: none"> • Electronic • Dimensions: 130 x 130 mm

* Our recommended design, which visually matches the product family

** Stop-and-go flush

*** Suitable for use with optional Geberit DuoFresh module, which boasts odour extraction, an orientation light and an insert for Geberit DuoFresh sticks

PUBLIC SANITARY INSTALLATIONS

FLEXIBLE URINAL SYSTEM WHAT MORE COULD YOU WANT?



↑ The flexible Geberit urinal system provides an easy way to meet the complex requirements of public and semi-public urinal systems.

Based on its tried-and-tested concealed Duofix and GIS installation systems, Geberit has developed a comprehensive solution which can be used to meet the complex requirements of public and semi-public urinal systems. The individual components of the Geberit urinal system are carefully matched to one another, ensuring smooth installation and maximum efficiency once it is fully operational.

Unparalleled flexibility: The system offers a concealed urinal flush control, a docking station integrated beneath the WC ceramic appliance, or completely waterless operation, depending on the customer's requirements and what is suitable for the structural conditions.

Exemplary efficiency: Optimum flush performance is achieved with as little as 0.5 litres of water.

Scrupulous hygiene: The rimless Preda and Selva urinal ceramic appliances reduce the amount of cleaning needed and prevent unpleasant odours.

Freedom of choice: The control unit works with a mains connection, a battery or a self-sustaining power supply. Retrofitting is also possible.

Universal design: The Preda and Selva urinal ceramic appliances and their associated partition walls fit neatly into every environment.

The Geberit urinal system is a decidedly economical solution that makes planning, installing and maintaining urinal systems considerably simpler.



↑ The practical docking station provides a convenient way of accessing the control unit at any time.



↑ The trap can be easily accessed from above, so the urinal ceramic appliance does not need to be removed for maintenance or cleaning purposes.



↑ Geberit Duofix element for urinal with visible urinal flush control.



↑ Geberit GIS element for urinal with hidden and vandal-resistant urinal flush control.

PUBLIC SANITARY INSTALLATIONS

INTELLIGENT TAP SYSTEM

THE SUPERIOR SOLUTION

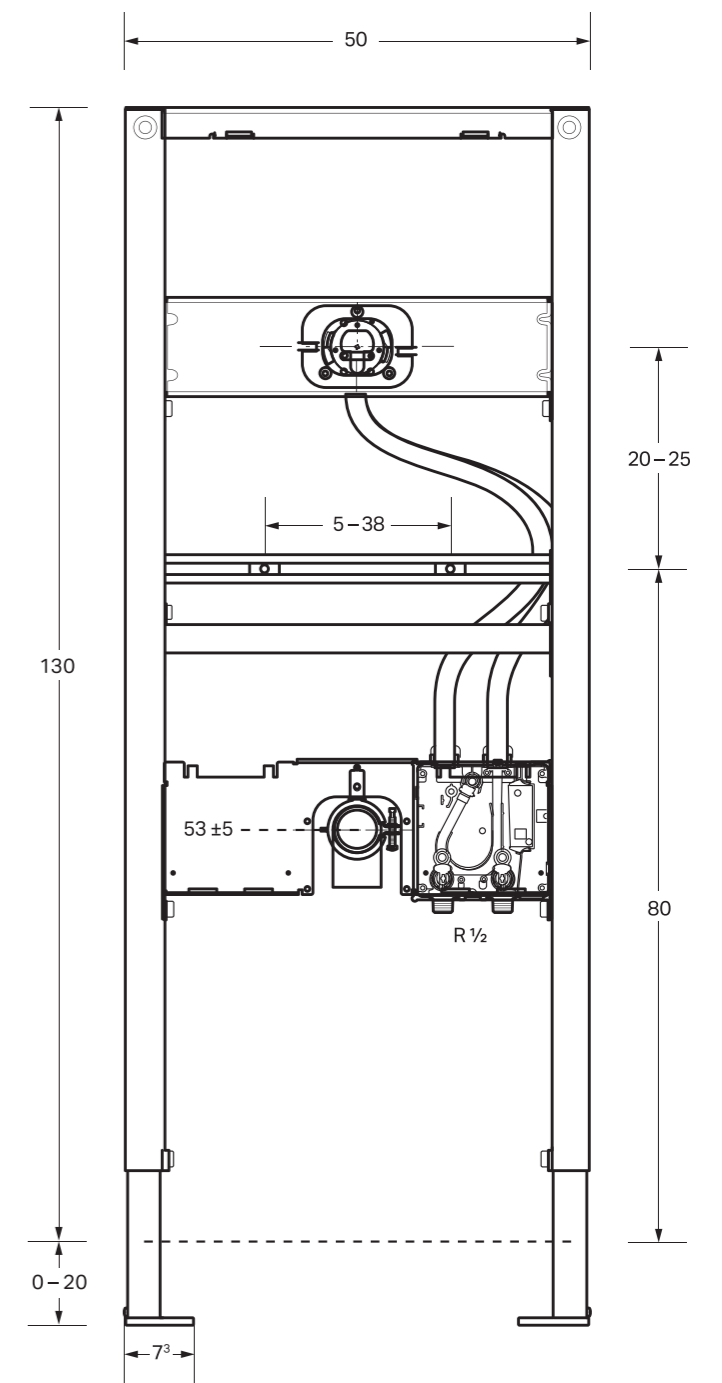

The benefits of touchless wall-mounted taps are clear: unhygienic touching of the chrome-plated elements can be avoided, there are no barriers to cleaning the washbasin, and there is the freedom to programme water consumption for each tap individually. Such taps are primarily used in sanitary facilities in public and semi-public buildings. In these highly frequented places, washbasin taps need to be able to withstand a lot, including rough use. Therefore, until now proper installation has been anything other than child's play.

Now, however, our touchless wall-mounted tap can be combined with Geberit Duofix and GIS installation systems, dramatically simplifying planning and installation as well as offering additional benefits.

Reliable planning: Combining the Geberit Brenta or Piave wall-mounted taps with the appropriate Geberit installation elements featuring a concealed function

box ensures dependable planning and clean execution.

High error tolerance: All key components, including the robust mounting plate for the wall-mounted tap, the function box, the washbasin fastening and the drain, are heightadjustable.

Vandal-resistant: As the wall-mounted tap is anchored firmly in the Geberit installation element and delicate components are stowed securely in a function box, the system offers virtually no opportunities for vandalism.

Easy to service: The technical components can be easily accessed – this makes servicing easy and saves time.

Elegant design: With their timelessly elegant design, the Geberit Piave and Brenta washbasin taps are a perfect match for a wide range of washbasin collections. The washbasin taps are made

of bright chrome, Stainless steel brushed and black matt.

Thermostatic mixer: The optionally



available thermostatic mixer reliably protects against scalding and ensures precise control of the water temperature.

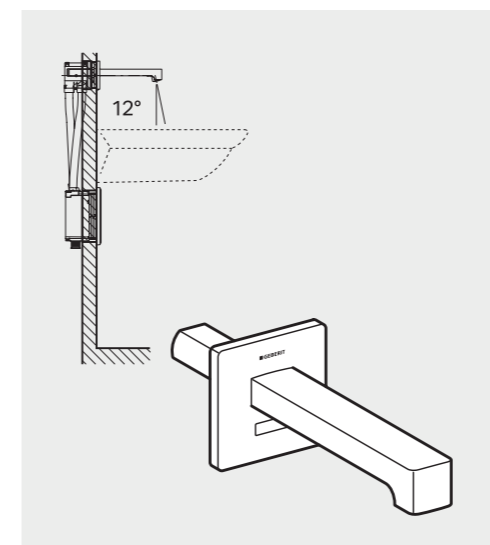

↑ Geberit washbasin tap Brenta, Wall mounting

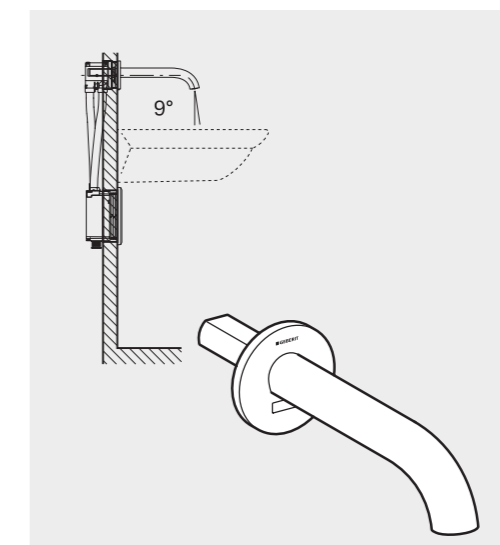

↑ Geberit washbasin tap Piave, Wall mounting

A separate function box which is located within easy access under the washbasin contains all the technical components except for the infrared sensor and enables particularly easy maintenance.



SMART CONFIGURATION VIA MOBILE DEVICE

EVERYTHING AT YOUR FINGERTIPS WITH THE CONTROL APP

The Geberit Control App makes life so much easier for service technicians, facility managers and plumbers alike. Geberit WC and urinal flush controls, washbasin taps and other products for semi-public and public facilities can be connected to a smartphone via Bluetooth®.

SIMPLE DOWNLOAD FOR IOS AND ANDROID

The free Geberit Control App is available to download from the App Store for iOS or from the Play Store for Android.



Geberit Control App



SMART CONTROLS

The Geberit Control App is compatible with a wide range of Geberit products. This intuitive app makes it possible to change device settings, read device information and carry out maintenance work via Bluetooth®.

SIMPLE REPLICATION OF SETTINGS

The clear user interface is designed to facilitate operation. With the Geberit Control App, all Geberit products installed in a sanitary room can be grouped and controlled efficiently. All configurations, such as the flush volume or interval settings can be saved and transferred to other devices of the same type. If, for example, a sanitary room is due to be cleaned, the cleaning mode can be applied to the entire group, which deactivates the flush actuation of all urinals in an in-row installation for a defined period of time.

This makes for an efficient approach to cleaning a sanitary room. Product-specific settings can be transferred conveniently and intuitively to other sanitary products via the app.

UP-TO-DATE ANALYSES

The app makes it possible to carry out up-to-date operational analyses and document the results. It is also possible to save and export statistical data, including the number of uses and the flush volume. This data forms a sound basis for optimising workflows and increasing cost efficiency.

SAFETY FIRST: PASSWORD PROTECTION

All Geberit controls can be password-protected against unauthorised access in the Geberit Control App. User authorisations can be transferred to third parties with full or partial access.

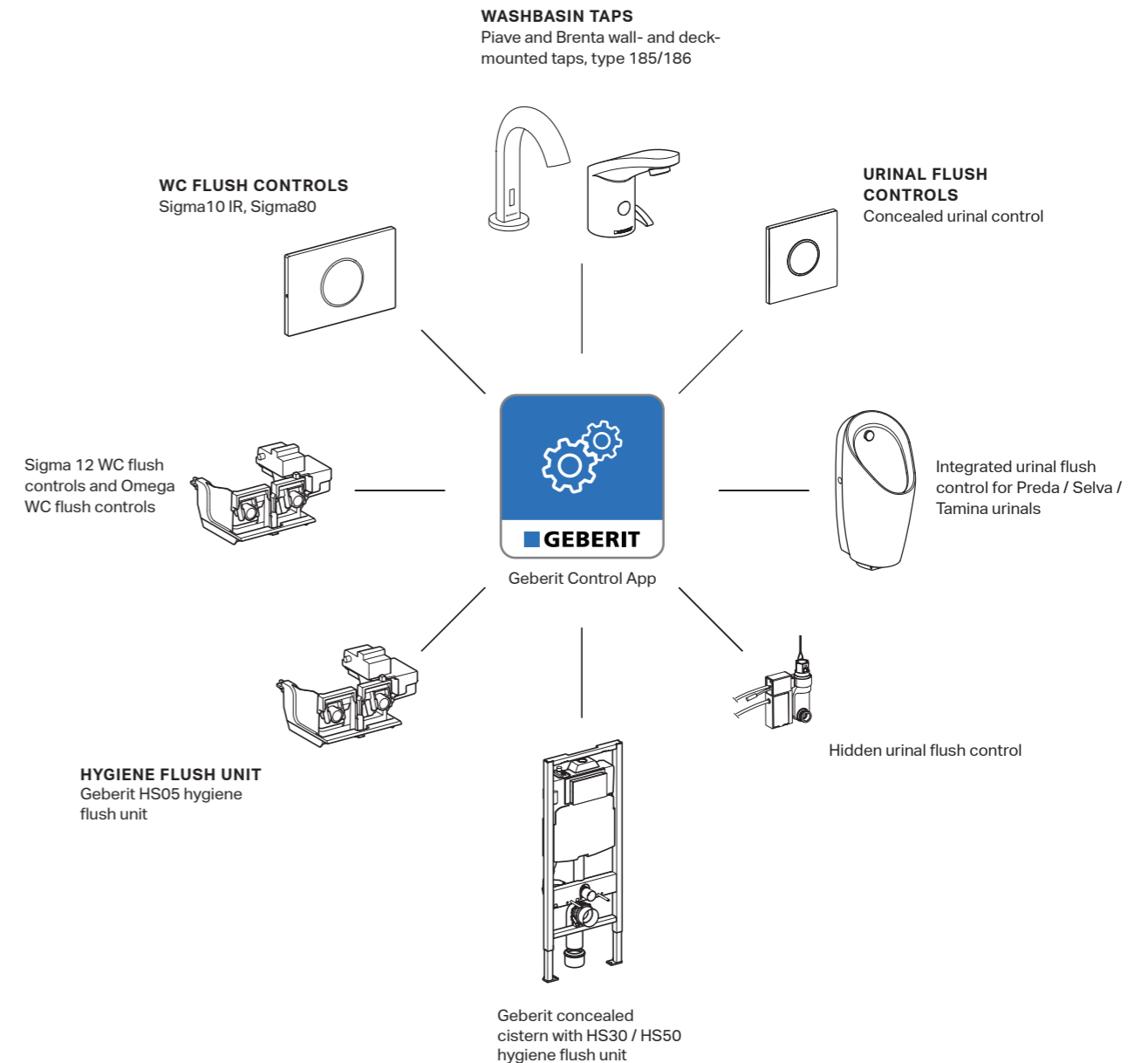



↑ Sophisticated fastening and insulation technologies ensure that the development of noise and sound transmission are kept to a minimum.

GEBERIT SOUND INSULATION QUIET LEADS TO A **GOOD QUALITY OF LIFE**

The installation systems from Geberit comprise solutions for sound insulation which have proven reliable time after time. They meet current standards and regulations and they guarantee that you and your customers can rest easy.

You can significantly reduce sound emissions such as those caused by discharge pipes or toilet flushes by selecting the right systems and appliances and having them professionally installed. The sounds cannot, however, be completely eliminated. As a result, Geberit places great importance on reducing sound transmissions. With the aid of suitable installation technology, appliances, water supply lines and discharge pipes can be decoupled from the building structure so well that the sanitary noises are only transferred throughout the building on a strongly reduced scale.

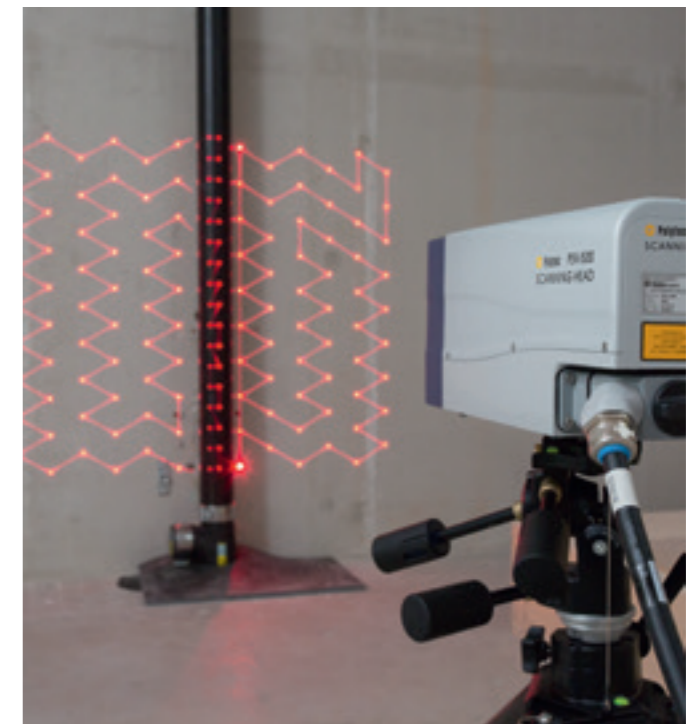

↑ Sound insulation is one of Geberit's core areas of expertise. The products are put through their paces using state-of-the-art measurement technology in the company's own Building Technology and Acoustics Laboratory, both on their own and within systems.

GEBERIT BIM PLUG-IN PLUG-IN AND PLAN

GEBERIT BIM PLUG-IN FOR AUTODESK REVIT®



The Geberit BIM Plug-in can be downloaded free of charge from any Geberit website www.geberit.co.za/bim/ or from the Autodesk app store www.apps.autodesk.com.

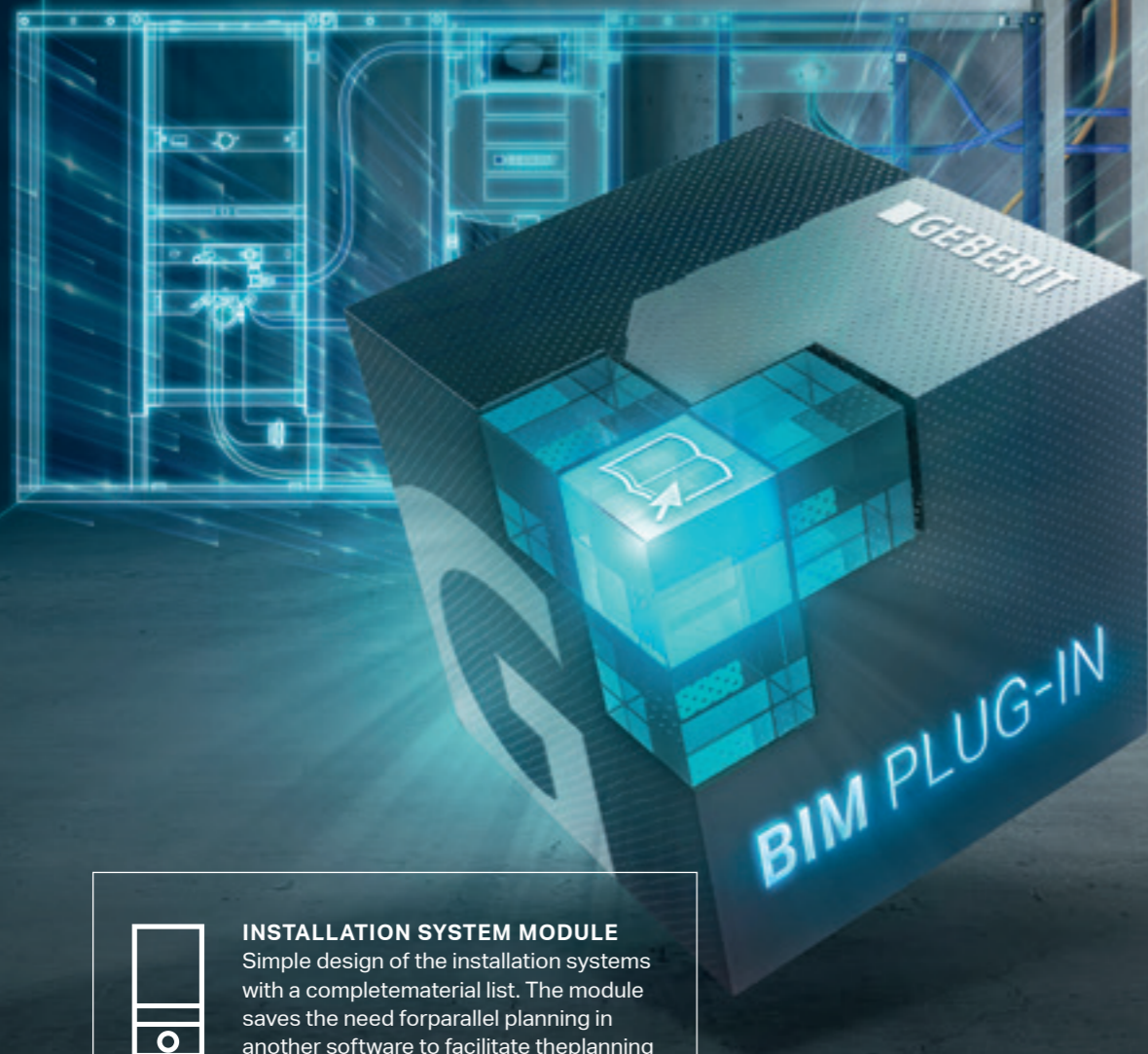

INSTALLATION SYSTEM MODULE
Simple design of the installation systems with a complete material list. The module saves the need for parallel planning in another software to facilitate the planning process.

Digital planning and construction using the BIM method has brought about fundamental changes in the construction industry. The holistic and model-based approach means that planning and construction processes can also be optimised and accelerated within the sanitary industry. Geberit's aim is to create simple and innovative solutions that offer sanitary engineers, architects and contractors added safety and greater cost-effectiveness. And with the new Geberit BIM Plug-in for Autodesk Revit®, another important step has been taken in the right direction.

STRAIGHTFORWARD SANITARY PLANNING

Finding up-to-date, complete and valid BIM content that is easy to manage is often a challenge in itself. The Geberit BIM Plug-in offers a reliable, integrated solution that meets all the needs for a straightforward and correct planning process.

AS CURRENT AS IT GETS

The direct connection to the Geberit product information management (PIM) system ensures that the user only uploads tested and approved BIM objects. This prevents the opportunity for planning errors caused by faulty or invalid BIM content.

WORLDWIDE PLANNING APPLICATIONS

The ability to select a specific language and region allows the Geberit BIM Plug-in to be used worldwide. What's more, local product catalogues also ensure that only products that are available locally are used.

MANUFACTURER-NEUTRAL TENDERS

Public projects are often tendered on a manufacturer-neutral basis. This is why Geberit BIM content can be changed to generic designations with a simple click in the built-in parameters. Once the tender is over, this can be reset so that the time-consuming replacement of objects in the BIM model is no longer necessary.

LIGHTWEIGHT AND HANDY BIM OBJECTS

Geberit relies on highly simplified, parametric geometries with all the metadata that is relevant for planning in the background. This avoids overloading CAD systems from the outset and allows for efficient planning. Despite their highly simplified geometry, Geberit BIM objects meet the requirements of all planning and construction phases, right through to facility management.

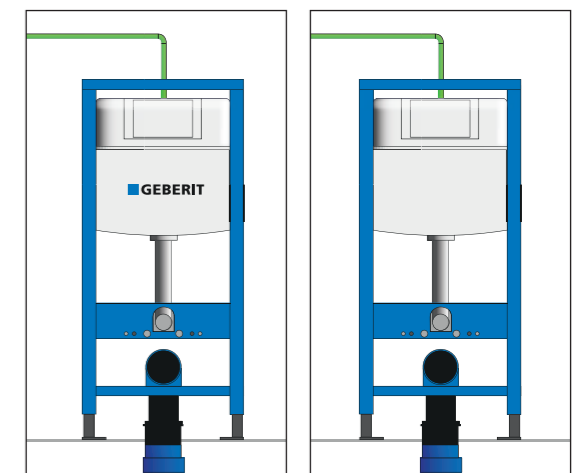

Manufacturer-specific versus manufacturer-neutral.

Geberit Southern Africa
06 Meadowview Ln, Meadowview
Business Estate
Linbro Park, Sandton AH
2090

011 444 5070

www.geberit.co.za